

Instrumentation Manifold Valves

SM2V / SM3V / SM5V Series

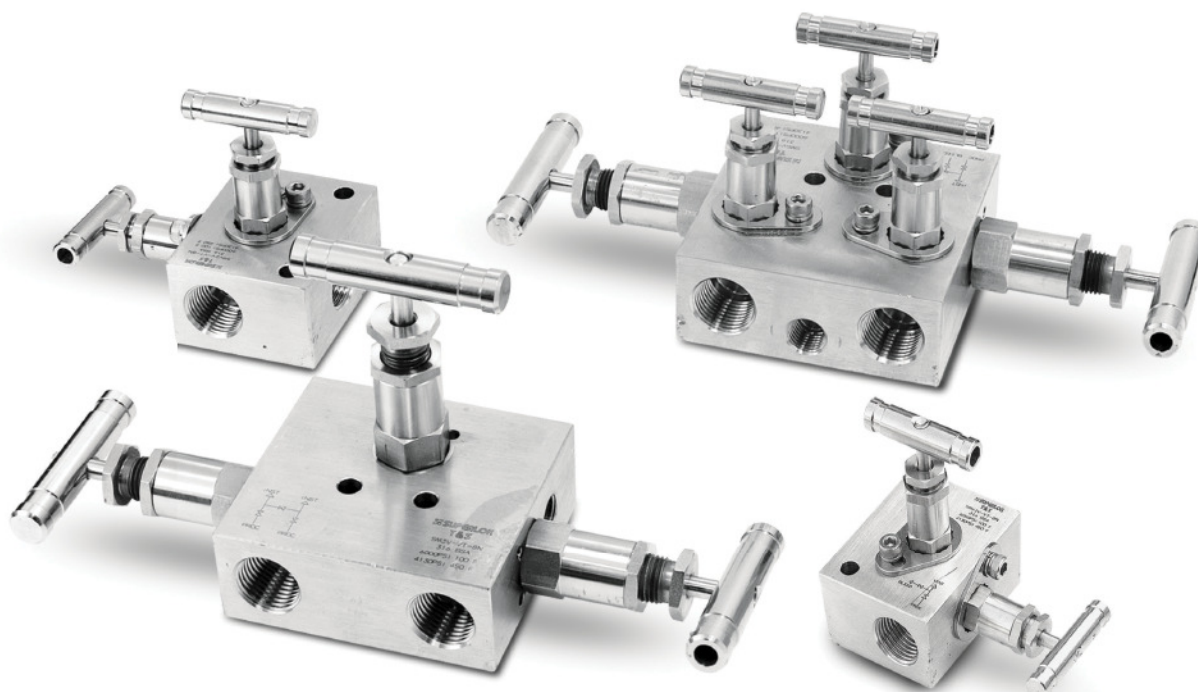

Features

- 2-,3-,and 5-valves Instrument manifolds valves.
- Pressure Rating up to 6000psig (413bar) @ 100°F(37°C)
- Temperature up to 1200°F(648°C) with optional Grafoil packing
- All 316 stainless steel construction with PTFE packing
- Each valve of every manifold is factory tested with nitrogen gas to a maximum allowable leak rate of 0.1scc/min.

Ordering Information

Example :	SM2	V	-	F	8N	-	M40
	1	2		3	4		5

1. Valve Series

- SM2 = 2-Valve Manifolds
- SM3 = 3-Valve Manifolds
- SM5 = 5-Valve Manifolds

2. Mounting Type

- V = Horizontal Style (Remote Mounting)
- VF = Horizontal Single Flange Style (Direct Mounting)
- VDF = Horizontal Dual Flange Style (Direct Mounting)
- VD = Vertical Style (Direct Mounting)

3. End Connection Type

- S = Superlok Female Tube Fitting
- F = Female Pipe Thread

4. Port Size

Size (inch)	1/2
Screwed NPT	8N

5. Body Material

- (Blank) = 316 Stainless Steel
- M40 = Alloy 400 (Monel)

※ For special sizes and configurations, please consult BMT (SUPERLOK) sales representative.

Technical Data

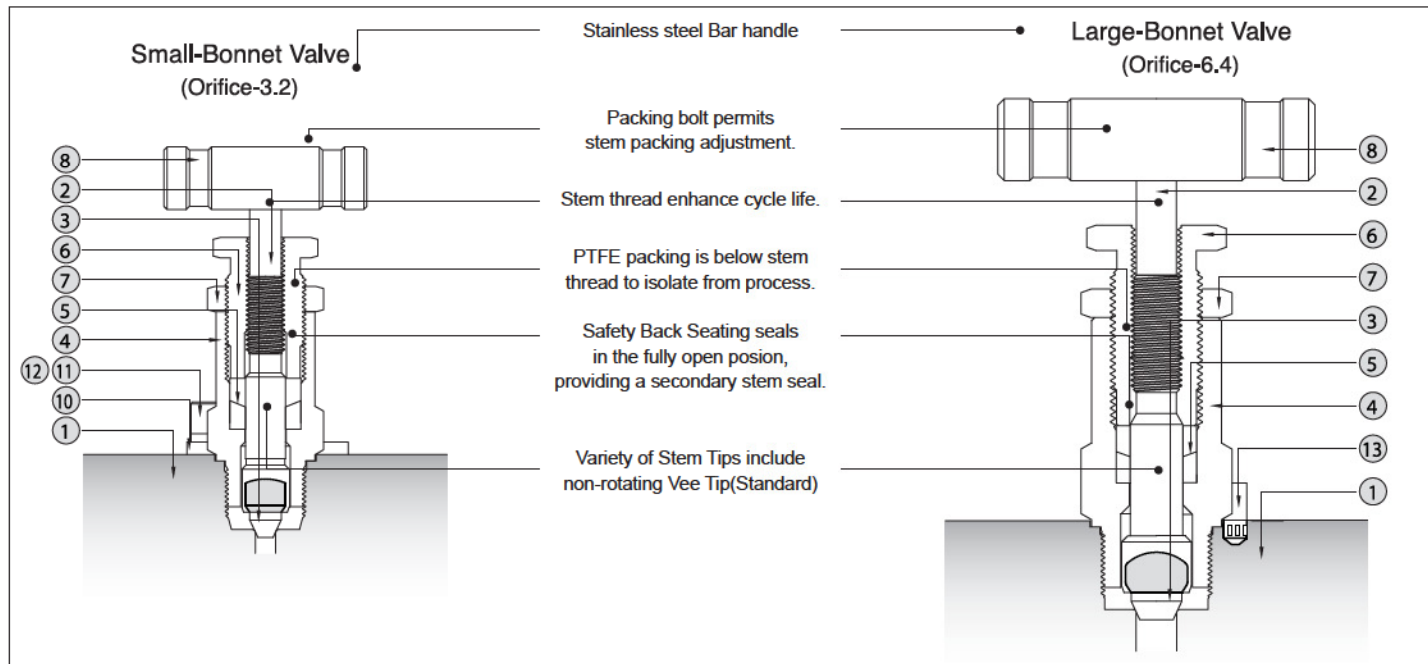

Materials of Construction

Component	Material Grade
*1 Body	SS316 / A276 or A479
*2 Stem	SS316 / A276 or A479
*3 Vee Tip	SS316 / A479
*4 Bonnet	SS316 / A276 / or A479
*5 Packing	PTFE Grafoil (optional)
6 Packing Bolt	SS316 / A276 / or A479
7 Lock Nut	SS316 / A276 / or A479
8 Handle	Stainless Steel
9 Set Screw	Stainless Steel
10 Locking Plate	Stainless Steel
11 Wrench Bolt	Stainless Steel
12 Spring Washer	Stainless Steel
13 Stop Pin	Stainless Steel

* Wetted components

Orifice

3.2mm (0.125 in.)	2-Valve Manifolds Block, Bleed Valve 5-Valve Manifolds Equalizer, Bleed Valve
6.4mm (0.250 in.)	3-Valve Manifolds Block, Equalizer Valve 5-Valve Manifolds Block Valve

Pressure-Temperature Rating

Component	SS 316	
	PTFE	Grafoil
*Packing Material	Working Pressure psig(bar)	
Temperature(°C)		
-65 (-53) to 100(37)	6000 (413)	6000 (413)
200 (93)	5160 (355)	5160 (355)
250 (121)	4910 (338)	4910 (338)
300 (148)	4660 (321)	4660 (321)
350 (176)	4470 (307)	4470 (307)
400 (204)	4280 (294)	4280 (294)
450 (232)	4130 (284)	4130 (284)
500 (260)	-	3980 (274)
550 (287)	-	3870 (266)
600 (315)	-	3760 (259)
650 (343)	-	3700 (254)
700 (371)	-	3600 (248)
750 (398)	-	3520 (242)
800 (426)	-	3460 (235)
850 (454)	-	3380 (232)
900 (482)	-	3280 (225)
950 (510)	-	3220 (221)
1000 (537)	-	3030 (208)
1050 (565)	-	3000 (206)
1100 (593)	-	2685 (184)
1150 (621)	-	2285 (157)
1200 (648)	-	1715 (118)

* Note

450°F(232°C) with standard PTFE packing.
1200°F(648°C) with Optional Grafoil packing.

Table of Dimensions for 2-Valve Manifolds

Horizontal Style (Remote Mounting)

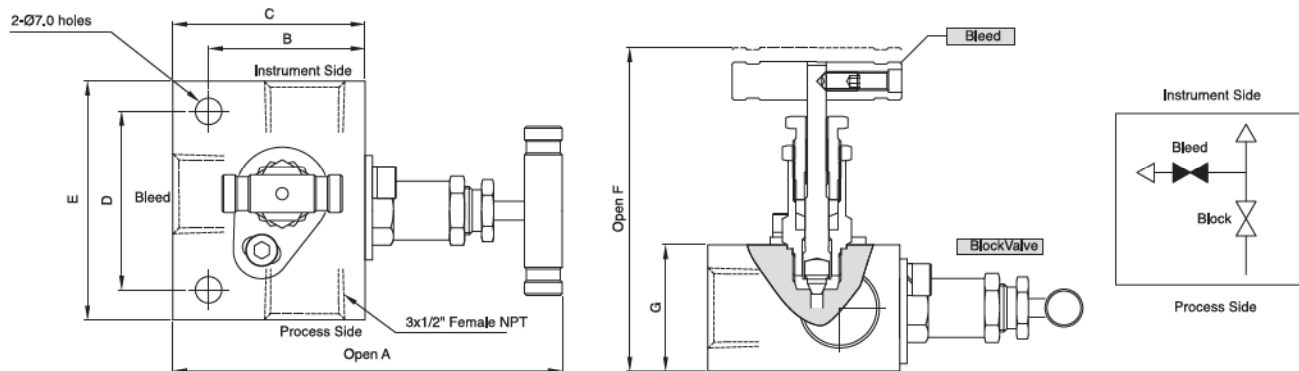

Part No.	End Connections			Weight Dimensions						
	Process	Instrument	Bleed	A	B	C	D	E	F	G
SM2V-F8N	1/2" Female NPT			103.5	41.5	51	47.5	63.5	85.9	33.5

Horizontal Single Flange Style (Direct Mounting)

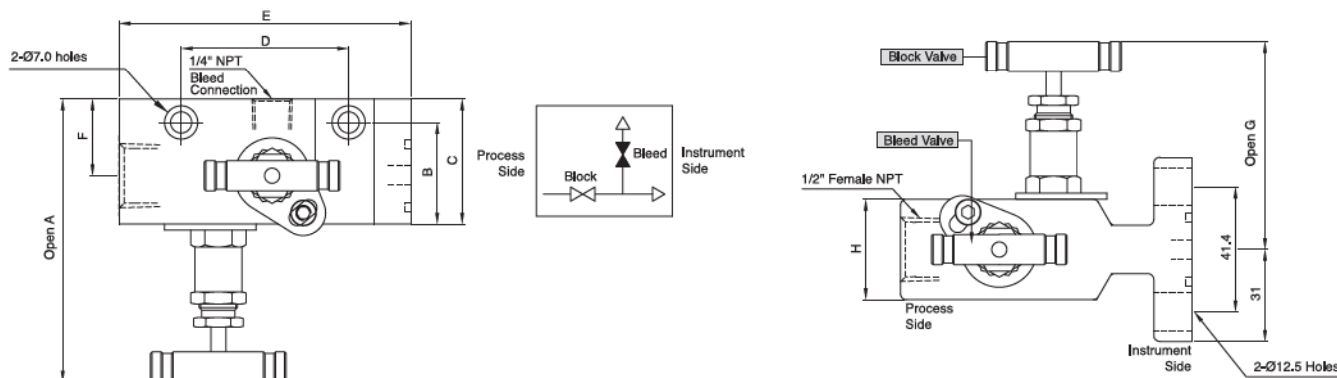

Part No.	End Connections			Weight Dimensions							
	Process	Instrument	Bleed	A	B	C	D	E	F	G	H
SM2VF-F8N	1/2" Female NPT	Flange	1/4" Female NPT	93.8	33.6	41.4	47.8	97.0	25.4	69.0	31.8

Vertical Style (Direct Mounting)

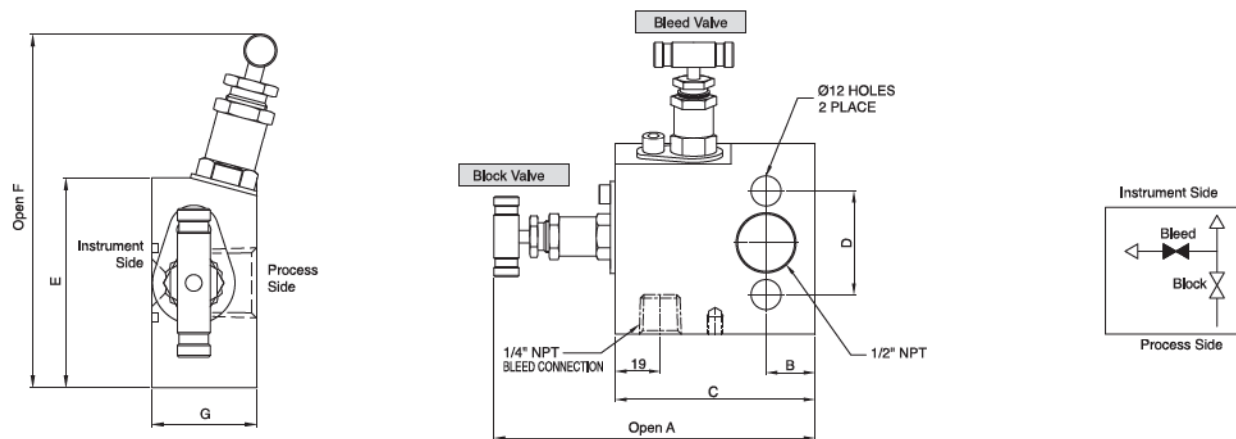

Part No.	End Connections			Weight Dimensions						
	Process	Instrument	Bleed	A	B	C	D	E	F	G
SM2VD-F8N	1/2" Female NPT	Flange	1/4" Female NPT	116.0	17.0	63.5	41.4	63.5	115.0	28.6

- Dimensions and Drawings are for reference only and are subject to change without prior notice.
- Unless otherwise specified, all dimensions are in millimeters.
- Sizes, pressure classes, and end connections not listed are available upon request.
- Dimensions shown with SUPERLOK nuts finger-tight, where applicable.

Table of Dimensions for 3-Valve Manifolds

Horizontal Style (Remote Mounting)

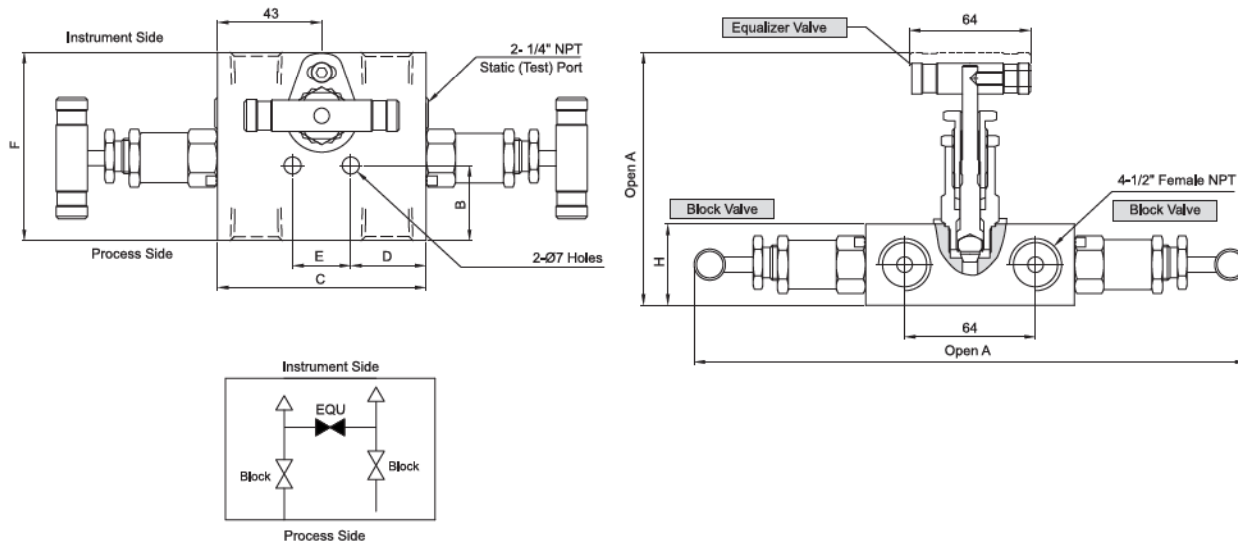

Part No.	End Connections		Weight Dimensions							
	Process	Instrument	A	B	C	D	E	F	G	H
SM3V-F8N	1/2" Female NPT		228.0	31.0	86.0	31.0	24.0	78.0	106.0	33.5

Horizontal Single Flange Style (Direct Mounting)

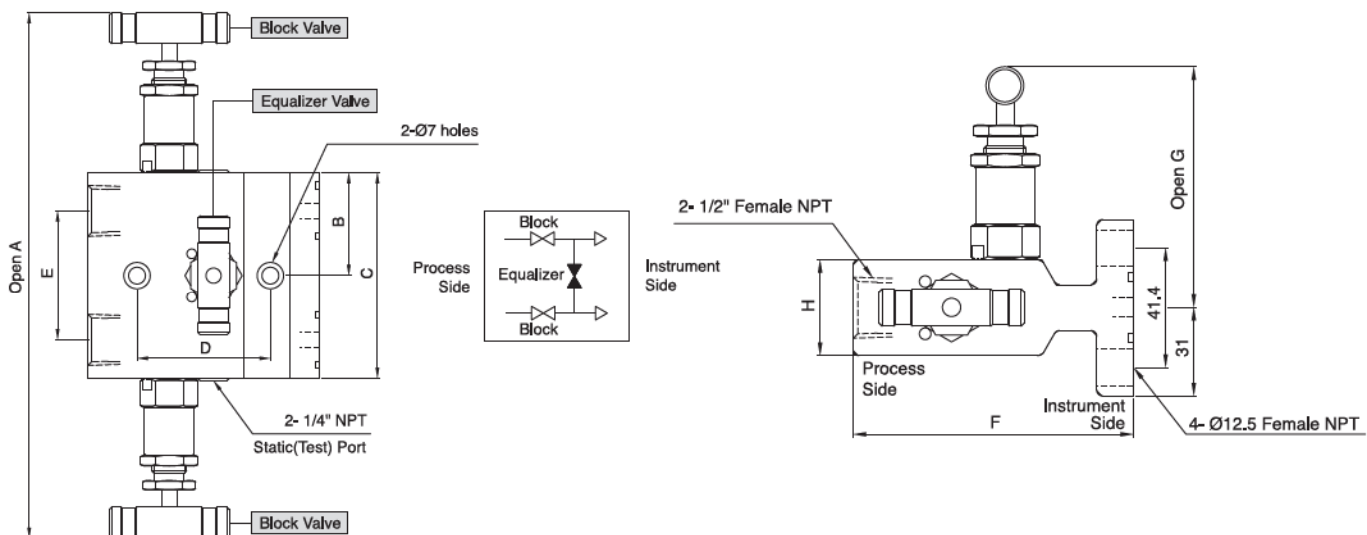

Part No.	End Connections		Weight Dimensions							
	Process	Instrument	A	B	C	D	E	F	G	H
SM3VF-F8N	1/2" Female NPT	Flange	228.0	43.0	86.0	55.6	54.0	97.0	87.7	31.8

- Dimensions and Drawings are for reference only and are subject to change without prior notice.
- Unless otherwise specified, all dimensions are in millimeters.
- Sizes, pressure classes, and end connections not listed are available upon request.
- Dimensions shown with SUPERLOK nuts finger-tight, where applicable.

Table of Dimensions for 3-Valve Manifolds

Horizontal Dual Flange Style (Direct Mounting)

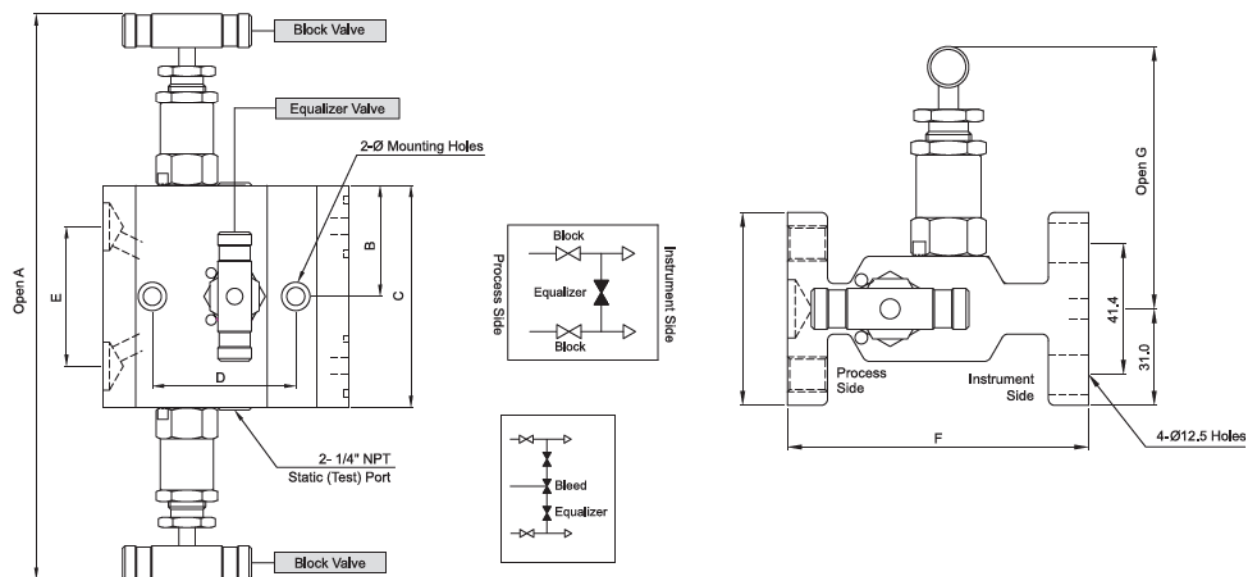

Part No.	End Connections		Weight Dimensions							
	Process	Instrument	A	B	C	D	E	F	G	H
SM3VDF	Flange	Flange	228.0	43.0	86.0	55.6	54.0	96.4	87.7	62.0

Vertical Style (Direct Mounting)

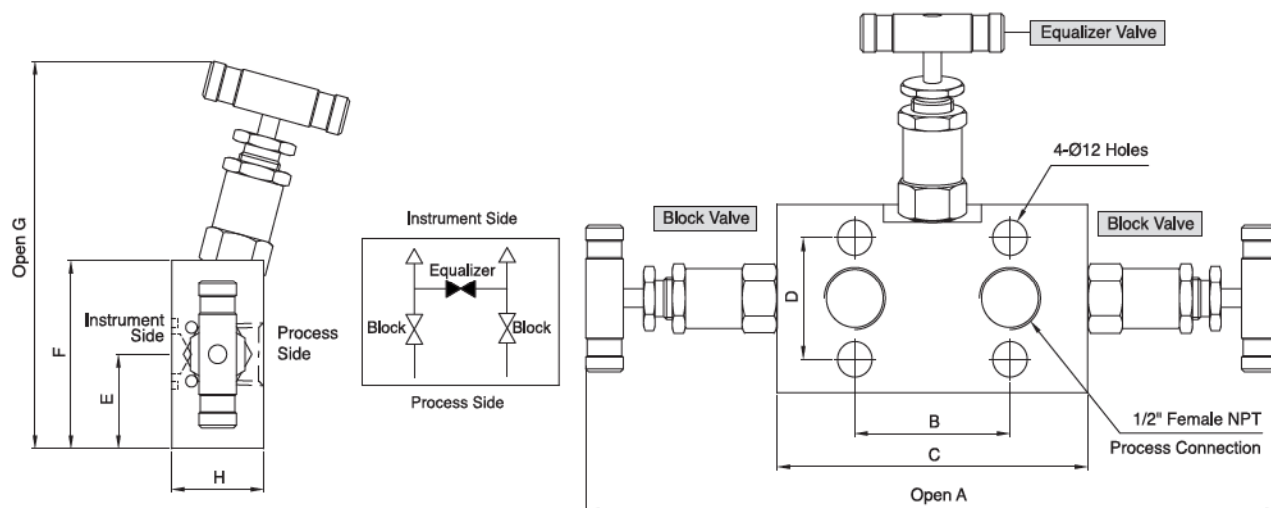

Part No.	End Connections		Weight Dimensions							
	Process	Instrument	A	B	C	D	E	F	G	H
SM3VD-F8N	1/2" Female NPT	Flange	250.0	54.0	108.0	41.4	32.0	64.0	136.0	32.0

- Dimensions and Drawings are for reference only and are subject to change without prior notice.
- Unless otherwise specified, all dimensions are in millimeters.
- Sizes, pressure classes, and end connections not listed are available upon request.
- Dimensions shown with SUPERLOK nuts finger-tight, where applicable.

Table of Dimensions for 5-Valve Manifolds

Horizontal Style (Remote Mounting)

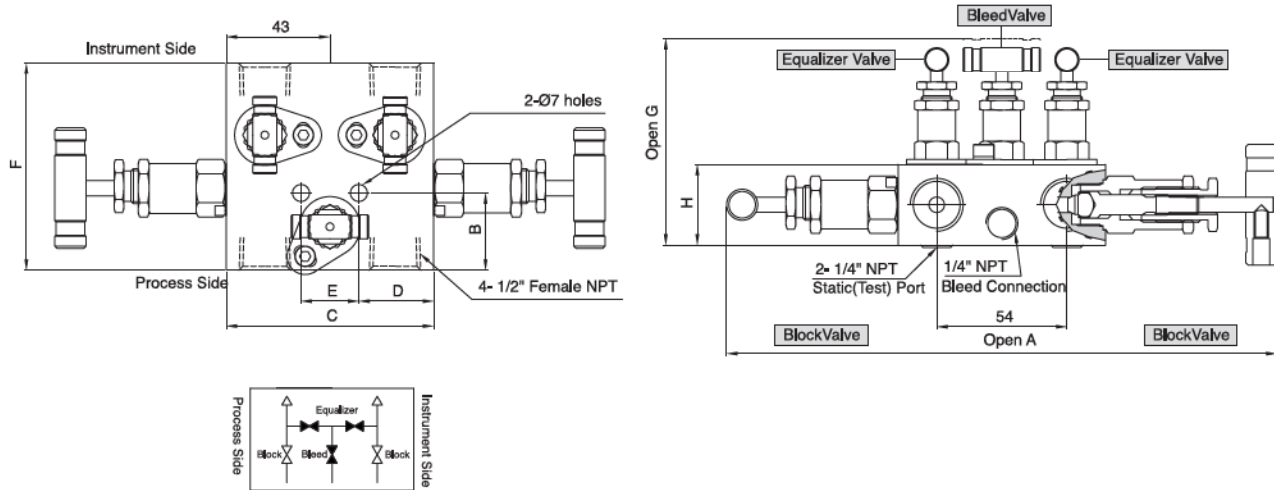

Part No.	End Connections			Weight Dimensions							
	Process	Instrument	Bleed	A	B	C	D	E	F	G	H
SM5V-F8N	1/2" Female NPT		1/4" Female NPT	228.0	32.0	86.0	31.0	24.0	86.0	85.9	33.5

Horizontal Single Flange Style (Direct Mounting)

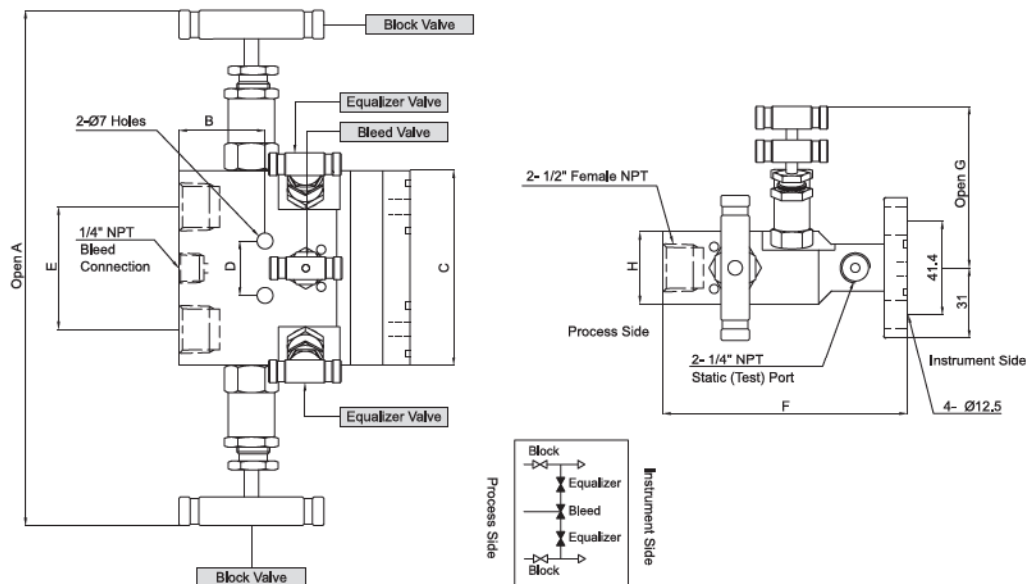

Part No.	End Connections			Weight Dimensions							
	Process	Instrument	Bleed	A	B	C	D	E	F	G	H
SM5VF-F8N	1/2" Female NPT	Flange	1/4" Female NPT	228.0	38.0	86.0	24.0	54.0	108.0	69.0	31.8

- Dimensions and Drawings are for reference only and are subject to change without prior notice.
- Unless otherwise specified, all dimensions are in millimeters.
- Sizes, pressure classes, and end connections not listed are available upon request.
- Dimensions shown with SUPERLOK nuts finger-tight, where applicable.

Table of Dimensions for 5-Valve Manifolds

Horizontal Dual Flange Style (Direct Mounting)

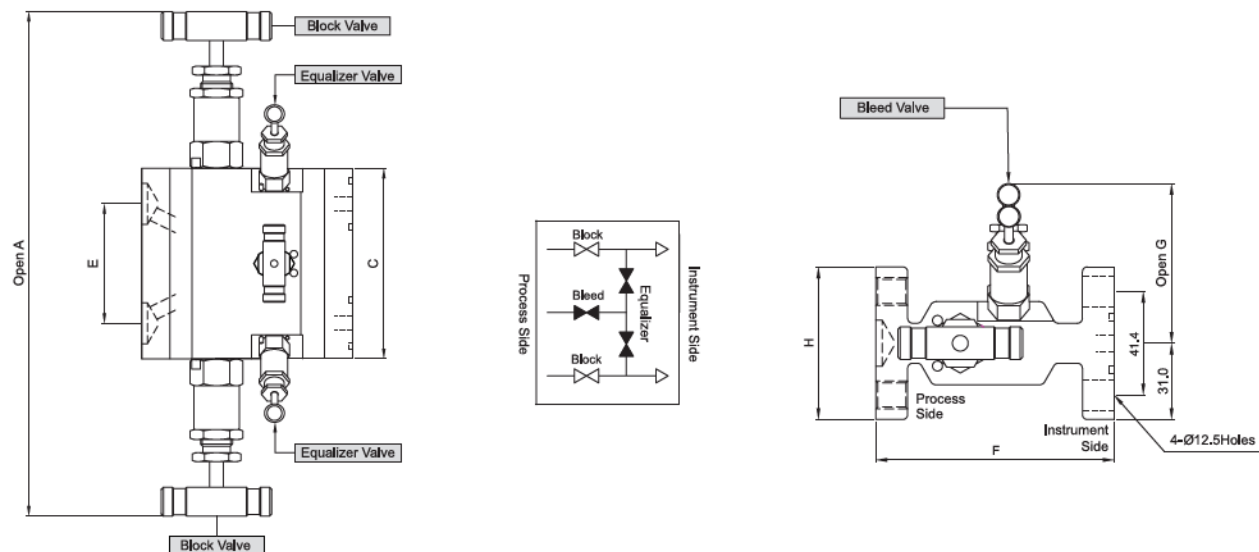

Part No.	End Connections			Weight Dimensions (mm)							
	Process	Instrument	Bleed	A	B	C	D	E	F	G	H
SM5VDF	Flange	Flange	1/4" Female NPT	228.0	32.0	86.0	24.0	54.0	96.4	69.0	62.0

Vertical Style (Direct Mounting)

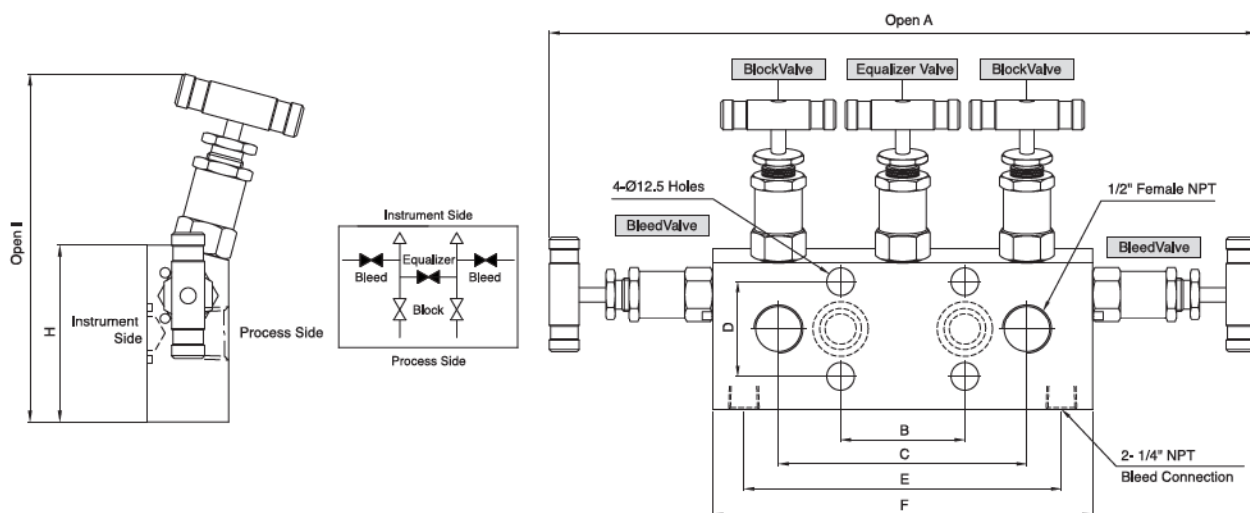

Part No.	End Connections			Weight Dimensions (mm)								
	Process	Instrument	Bleed	A	B	C	D	E	F	G	H	I
SM5VD-F8N	1/2" Female NPT	Flange	1/4" Female NPT	312.0	54.0	102.0	41.4	138.0	158.0	148.0	76.2	32.0

- Dimensions and Drawings are for reference only and are subject to change without prior notice.
- Unless otherwise specified, all dimensions are in millimeters.
- Sizes, pressure classes, and end connections not listed are available upon request.
- Dimensions shown with SUPERLOK nuts finger-tight, where applicable.

Manifolds Accessories

Flange Bolts & Seals

Flange Bolts

Flange Bolt	Part No.	Hex Size mm (in.)	Length mm (in.)	Threads	Bolt Material Designator
Standard Hex Head Bolt	SM-FB	15.87 (5/8)	25.0 (1.0)	7/16 - 20	Stainless Steel : -S Carbon Steel : -C
Long Stud with Hex Nut	SM-LFB		58.0 (2.28)		
Short Hex Head Bolt	SM-SFB		22.2 (0.875)		
Direct Mounting Bolt	SM-DM8		45 (1.77)		



Flange Seals

Seal Material	Ordering No.	Temperature Rating
Viton	SM - FS - V	-20°F ~ 450°F (-28°C ~ 232°C)
PTFE	SM - FS	-65°F ~ 250°F (-53°C ~ 121°C)
Grafoil	SM - FS - GR	-65°F ~ 1000°F (-53°C ~ 537°C)

Concentric & Eccentric Oval Flange

- Eccentric Flanges and Pipe Nipple allow connections of flange - to - flange manifolds to process flange taps or process root valves.
- Standard connection is female NPT 1/2".
- Concentric & eccentric oval flange ordering number : Concentric oval flange female NPT 1/2" : SM - COF - F8N
Eccentric oval flange female NPT 1/2" : SM - EOF - F8N
- Dimensions, in millimeters (inches), are for reference only and are subject to change.

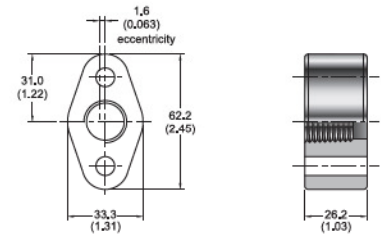

Concentric & Eccentric Pipe Nipple

Type	Part No.	Material	Pressure Rating @70°F (20°C) psig (bar)	Temperature Rating F (°C)	Pressure Rating @Max. temperature
Concentric	SM - CPN - S	SS316 / A276	10000 (689)	-65 to 1200 (-53 to 648)	2850 psig @ 1200°F (196 bar @ 648°C)
	SM - CPN - C	Carbon Steel / A108	8000 (551)	-20 to 350 (-28 to 176)	6970 psig @ 350°F (480 bar @ 176°C)
Eccentric	SM - EPN - S	SS316 / A276	7500 (516)	-65 to 1200 (-53 to 648)	2140 psig @ 1200°F (147 bar @ 648°C)
	SM - EPN - C	Carbon Steel / A108	6000 (413)	-20 to 350 (-28 to 176)	5230 psig @ 350°F (360 bar @ 176°C)

* Dimensions, in millimeters (inches), are for reference only and are subject to change.

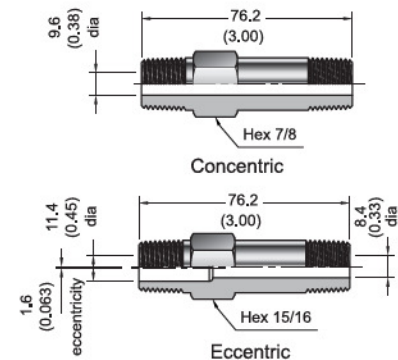

Calibration Fittings



Calibration fittings connect directly to the bleed port of differential pressure transmitter.

Material	Part No.	SUPERLOK O.D	Stright Male Thread
Stainless Steel / A276	SCAL4 - 1U	1/4"	1/4 - 28UNF
	SCAL4 - 2U		5/16 - 24UNF

Vent plugs, Bleed & Purge Valves

- Bleed & Purge valves used to vent to atmosphere and to assist in calibration.
- Sizes: 1/4, 3/8, and 1/2 in. male NPT.
- For more information, see the Bleed Valve and Purge Valve on page(391, 392)

